



## SPECIFICATIONS

Watts	100W, 150W
Lumens	11500LM (100W) 17250LM (150W)
CRI	70
Input	100-277V, 277-480V
Driver	Constant Current, Class 2 6kV Surge Protection
Dimming	0-10V to 10%
Temperature	4000K, 5000K, 5700K
Distribution	Type 3, Type 4, Type 5
Dimensions	17.3"L x 15.3"W x 5.4"H
Material	Die Cast Aluminum, Acrylic
Finish	Bronze
Mounting	Mounts to square and round poles with adapters.
Certifications	cETL, DLC, RoHS
Applications	Area Light
Lifespan	50,000+ Hours
Warranty	5 Years

## ORDERING GUIDE

Part	Watts	Temperature	Voltage	Distribution	Mounting	Options
JLAL-034-ARL-03	100: 100W	40K: 4000K	120: 120V	3: Type 3	SF: Slip Fitter	PC: Photocell
	150: 150W	50K: 5000K	277: 277V	4: Type 4	PM: Pole Mount	SH: Shorting Cap
		57K: 5700K		5: Type 5	TR: Trunion	
					WM: Wall Mount	

MOUNTING



Slip Fitter



Square/Round Pole Mount



Trunnion



Wall Mount

ACCESSORIES



Photocell



Shorting Cap

DIMENSIONS

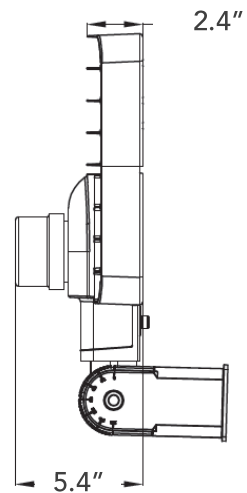
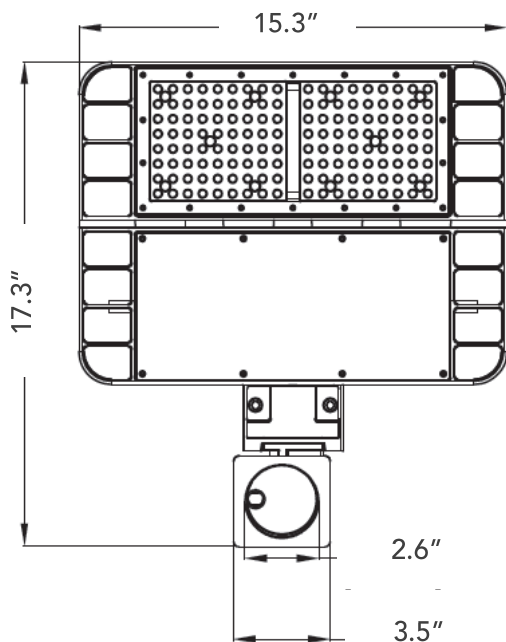

INSTALLATION

- 1. Install mount bracket to pole
- 2. Connect fixture to bracket
- 3. Wire & Secure with screws

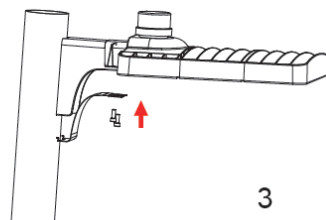
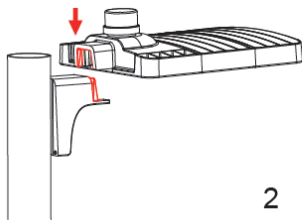
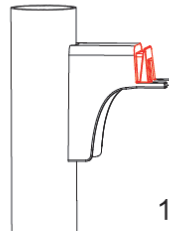

Slip Fitter

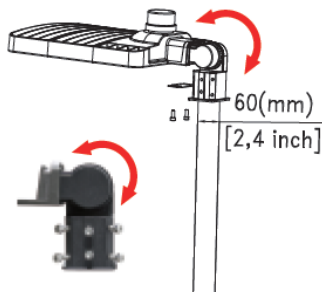

Square / Round Pole Mount

Trunnion

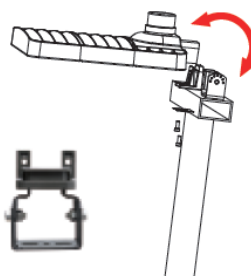

Wall Mount

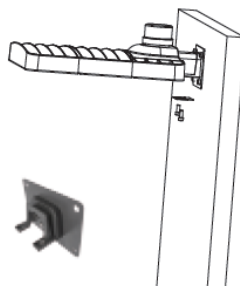
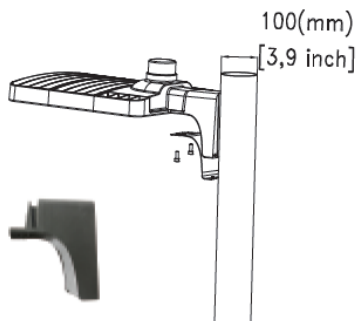

## PHOTOMETRICS

### Type 3

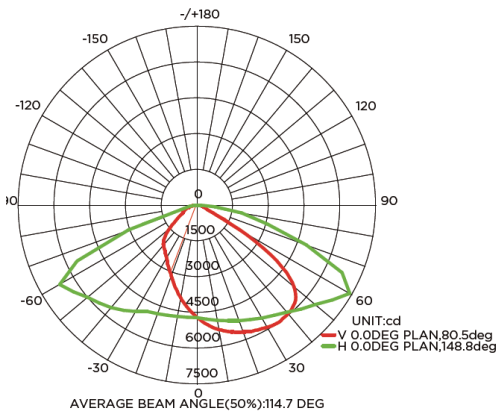
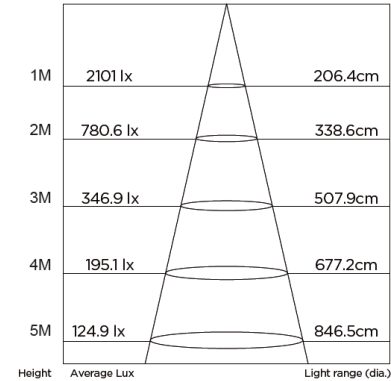

### Type 4

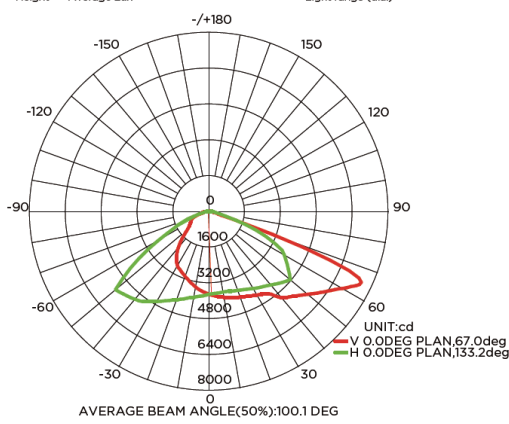
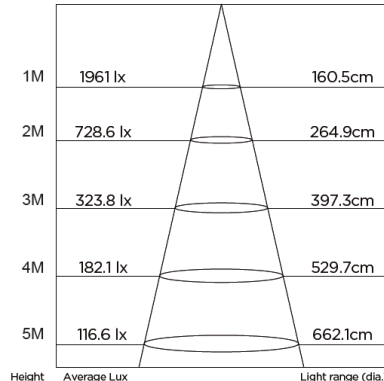

### Type 5

